

ASUKA 2GOU

軒先・利足方向断面 S = 1/10

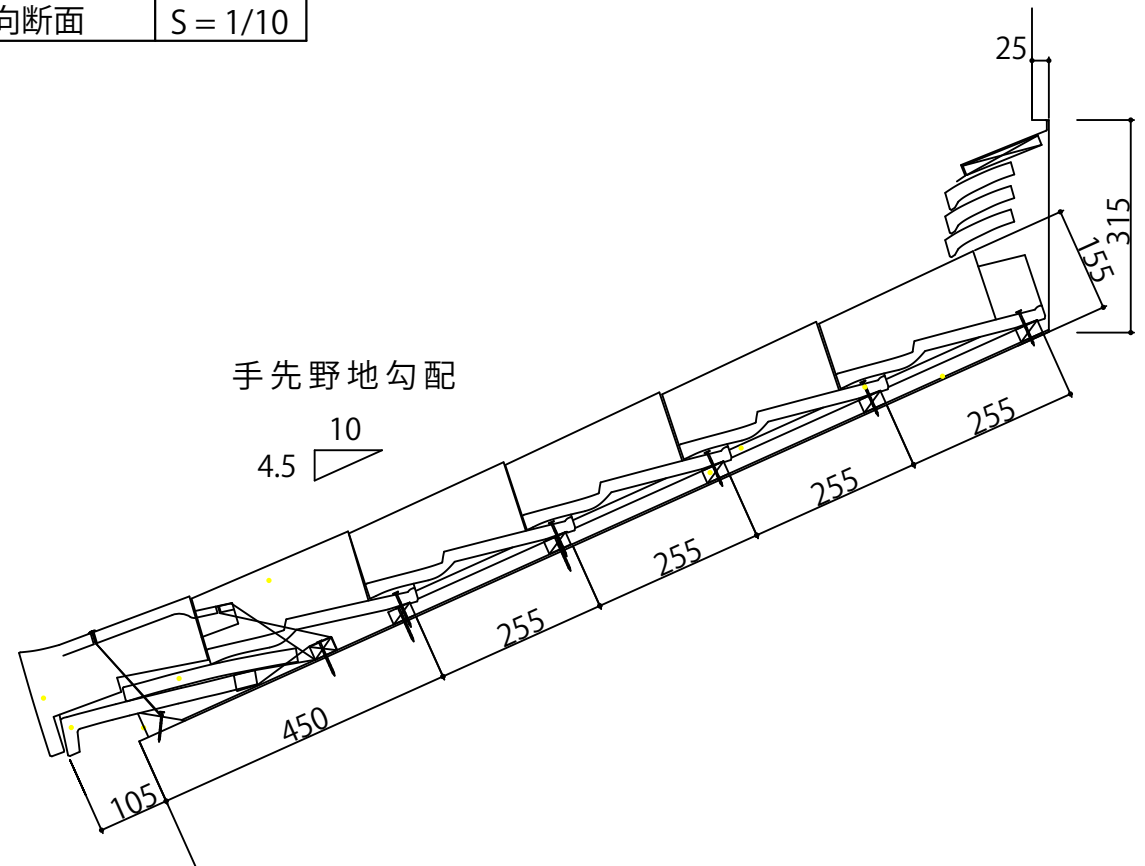

軒積断面 S = 1/10

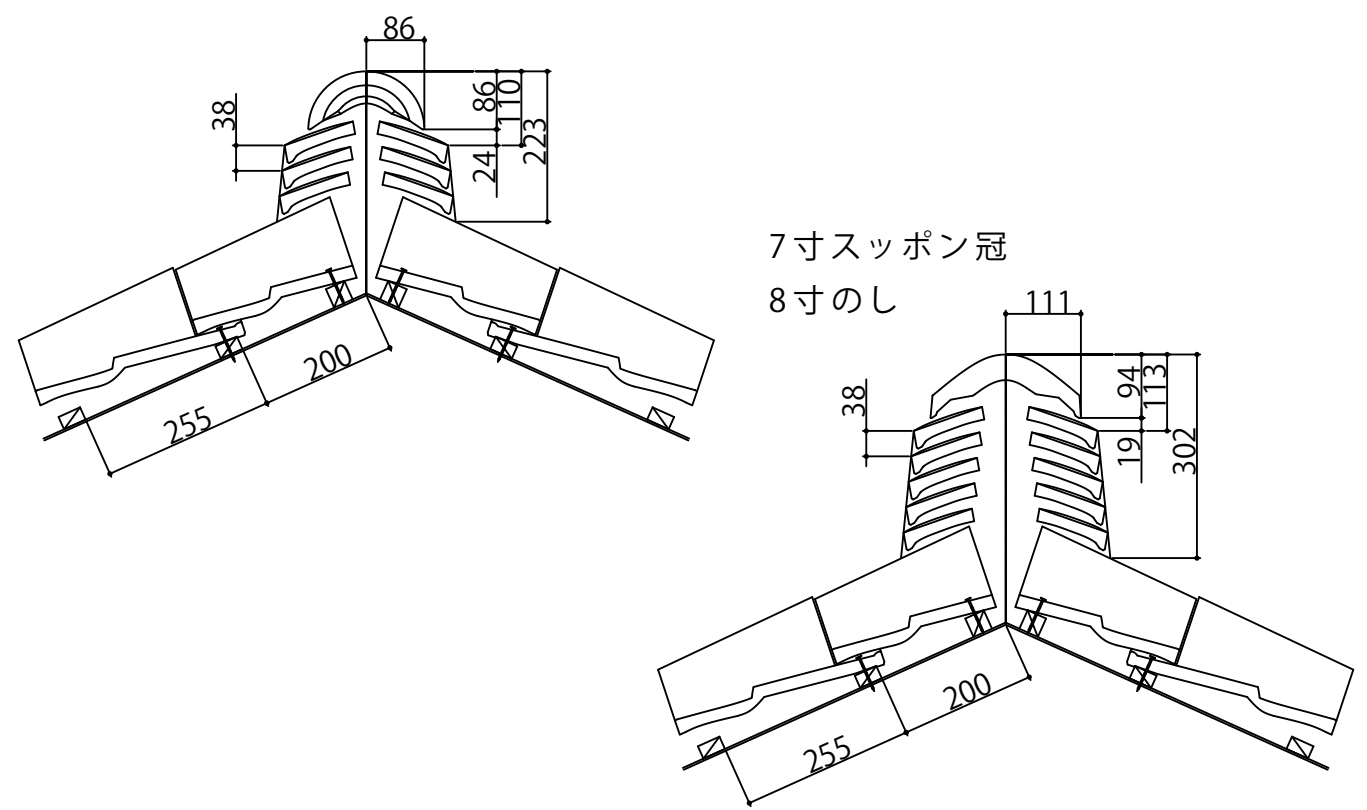

ケラバ・利巾方向断面 S = 1/10

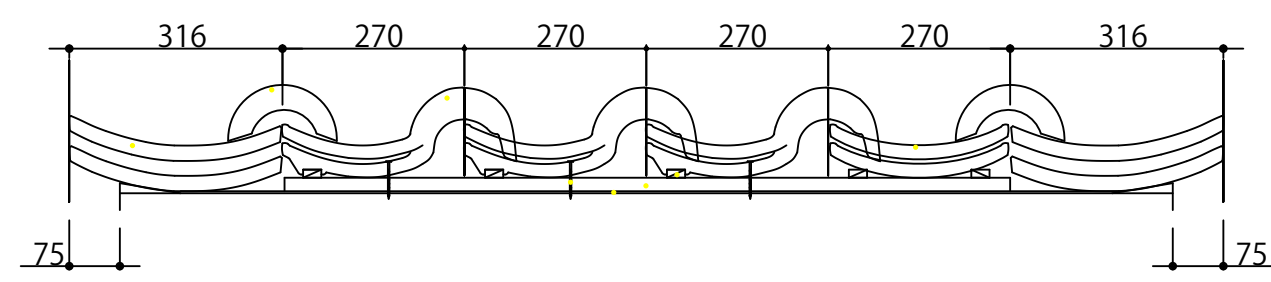

壁際付けのし S = 1/10

